

TUM

INSTITUT FÜR INFORMATIK

The Endo[PA]R System for Minimally Invasive Robotic Surgery

Istvan Nagy, Hermann Mayer, Alois Knoll



TUM-I0320
Dezember 03

TECHNISCHE UNIVERSITÄT MÜNCHEN

TUM-INFO-12-I0320-0/1.-FI

Alle Rechte vorbehalten

Nachdruck auch auszugsweise verboten

©2003

Druck: Institut für Informatik der
 Technischen Universität München

The Endo[PA]R System for Minimally Invasive Robotic Surgery

István Nagy, Hermann Mayer, Alois Knoll

Technische Universität München, 85747 Garching, Germany,

knoll@in.tum.de,

mayerh@in.tum.de,

nagy@in.tum.de,

WWW home page: <http://www6.in.tum.de>

Abstract. During the last decade minimally invasive surgery has become the leading method for many surgical interventions. Unlike open surgery, minimally invasive surgery only needs small incisions in the patient's body. This leads to a drastic reduction of tissue trauma and therefore to shorter recovery times. In the beginning, this technique was performed manually with specialized instruments. Surgeons had to cope with restricted manipulability of the end-effector and poor visual feedback. These drawbacks were overcome by employment of dedicated robotic systems. We present an exhaustive overview on similar systems, both in research and for commercial use. Despite the advantages the systems offer, there are also needs of surgeons that have not been met. The most crucial issue is the lack of sensitive force feedback. This often leads to unpleasant side effects like damaging thread material or even lacerating healthy tissue. It is in particular this shortcoming that results in fatigue of the operator, due to visual compensation of the missing haptic feedback. Incorporation of force feedback in systems for robotic surgery is therefore a crucial factor in improving reaction to tissue contact. Our aim is to provide the surgeon with an operation environment very similar to manual instrumental surgery (i.e. the surgeon can always feel forces exerted on the instruments). Therefore we have developed the Endo[PA]R system, which we describe below in detail. Several experiments demonstrated the usefulness of this setup as an evaluation platform.

1 Introduction

Advanced surgery techniques, mainly developed in the last decades, dramatically increased life expectancy and the quality of life after surgical procedures. Today no one worries about diagnoses like appendicitis or hernia, since their (often ambulatory) treatment became routine in modern medical centers.

But the beginnings were often accompanied by excessive loss of blood and infections, due to the large incisions made. Many patients deceased as a consequence of the surgical procedure and not the disease itself. A huge amelioration, apart from technical improvements in the operating room, was brought by the introduction of the minimally invasive surgery (MIS) in the 1980s. In contrast to

conventional open surgery the operation area is accessed through small incisions: usually at least two for the instruments, one for the endoscope and sometimes one for CO_2 insufflating. Figure 1a shows a schematic overview of a minimally invasive procedure, figure 1b is a snapshot shortly before a real MI procedure. Note the difference to a conventional open procedure as shown in figure 1c.

There are obvious advantages compared to open surgery: reduced trauma and pain due to the smaller incisions, shorter rehabilitation time (which results in shorter hospital stays), and last but not least cosmetical considerations. But despite the advantages this new technique did not produce the response from the public as hoped. The reason therefor is that advantages at the patient's side are almost countervailed against disadvantages at the surgeon's side. The surgeon has to deal with orientation problems due to reduced sight, finding anatomical structures often becomes a challenge. The instruments have to be handled around so called *trocar points* on the patient's abdomen, restricting the degrees of freedom inside the body to four and resulting in a reverse hand motion. Furthermore the surgeon's hand tremor gets amplified by the long instruments, and there is no haptic feedback, compensating it's absence visually has been found quite fatiguing.

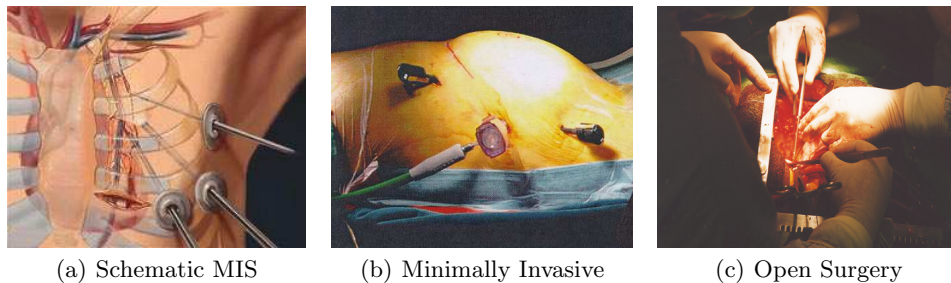

Fig. 1. Open vs. Minimally Invasive Surgery

To circumvent some of the problems of conventional minimally invasive surgery robotic technologies were integrated. There are three different main areas in which robotic surgery systems became commercially available and entered medical centers for daily use. All have to cope with different requirements, so that a "general purpose" surgery robot doesn't make sense and consequently doesn't exist.

1. **Bone surgery** The most typical actions in this area are high precision drilling and milling, which leads to high forces and vibrations. Therefore adequately modified industrial robots are often used.
2. **Neurosurgery** In this field the most important requirement is precision in a very limited workspace, but there are no mentionable forces to apply. The biggest challenge is navigation, which can be planned only preoperative using medical imaging techniques.

3. **Abdominal/Thorax surgery** We have the biggest workspace in this area leading to special requirements to the robot arms and endeffectors. Dealing with highly deformable organs in an online teleoperative manner (in the other two cases above mainly preoperatively planned actions are executed) asks for high fidelity force feedback.

During the 1990s several robotic systems for surgery leaved research institutes and entered dedicated medical centers for evaluation purposes or even daily practice. The first application area is represented by the systems *Caspar*TM from Universal Robotic Systems Ortho GmbH [5] and *Robodoc*TM from Integrated Surgical Systems [4] (Figure 2). Integrated Surgical Systems provides also the system *NeuroMate*TM (Figure 3a) which together with *PathFinder* from Armstrong Healthcare Ltd. [6] (Figure 3b) represent robotic neurosurgery.

The two most technically mature systems are *daVinci*TM (Figure 4) from Intuitive Surgical Inc. [2] and *Zeus*TM (Figure 5) from Computer Motion Inc. [3] which we want to describe in more detail. Both are general purpose teleoperation systems for abdomen and thorax surgery, but mainly evaluated in the field of heart surgery. There is on both systems only position control possible, and therefore no autonomy can be achieved. None of them provides instrumental side force/torque sensory, nor (the possibility of) haptic feedback at the master console. Motion scaling, tremor filtering, optical magnification and stereo vision is available with both systems. The instruments differ in the number of degrees of freedom, the Intuitive system has 6, while the Zeus setup has only 5.

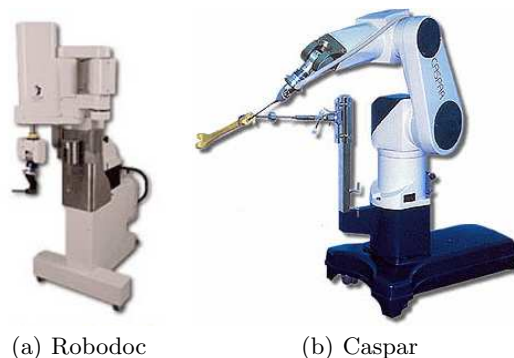

Fig. 2. Bone surgery robots

The advantages of robotic surgery are obvious: very high precision, the possibility of integration of preoperative planning data using medical imaging techniques. Unfortunately there are also a few disadvantages: high costs resulting from hardware costs on the one hand, and from increased personnel training time on the other hand. Nonetheless we think that robot assisted surgery will rev-



(a) PathFinder



(b) NeuroMate

Fig. 3. Neurosurgery robots



(a) daVinci Console

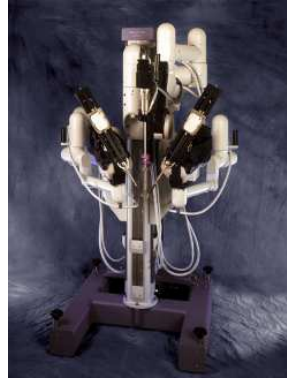

(b) daVinci Arms

Fig. 4. The daVinci system from Intuitive Surgical



(a) Zeus Console



(b) Zeus Arms

Fig. 5. The Zeus system from Computer Motion

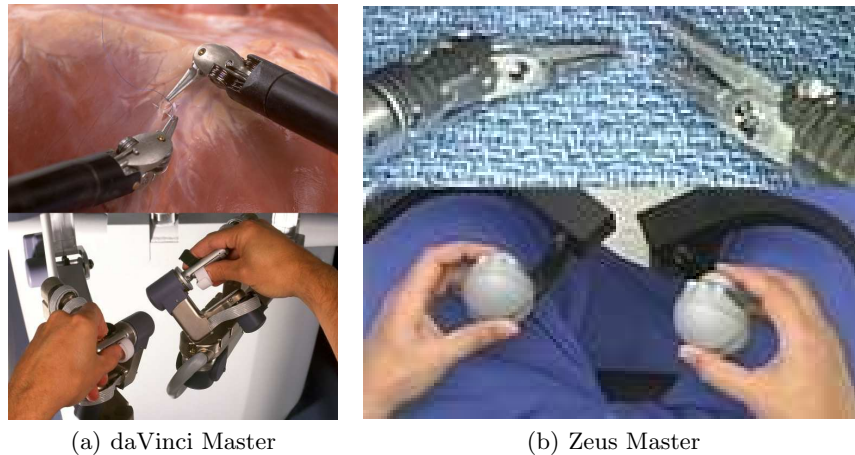

Fig. 6. Masters of the two systems daVinci and Zeus

olutionise today's operations comparably to imaging techniques like Computed Tomography, Magnetic Resonance Imaging and Positron Emission Tomography.

2 Minimally Invasive Robotic Surgery

In this section we give a brief technological overview of robotic surgery systems as they should be from both the system architecture and configuration point of view. We confine ourselves to real telepresence (online human-machine interaction) systems like the *daVinciTM* and *ZeusTM* setups. We identify three main components:

1. **Master** This subsystem (also called user interface, see figures 4a and 5a) is the surgeon's workplace and has to feedback modalities of the visual, kinesthetic and tactile senses generated using appropriate actuator hardware (see the point below). The surgeon's actions at the input devices (misleadingly also called *masters*) are immediately transformed to the adequate actuator movements, the possibility of scaling and tremor suppression increase usability and safety. A high quality stereo vision system is indispensable, the lack of depth information has been found very hard to compensate. Unfortunately there is no commercially available system, which provides kinesthetic or tactile feedback. Many research projects, also including ours, deal with this very important issue.
2. **Slave** Located at the patient's side this subsystem (also called actuator, see figures 4b and 5b) consists of two main components: the robot arms and the minimally invasive surgical instruments (see upper part of figures 6a and 6b). The distinction between arms and instruments is due to the fact, that the possibility of changing the instruments during a surgical procedure is

one of the most important requirements. Actuated arms and instruments are expected to give full manipulability inside the body, providing the same degrees of freedom as the human hand. The robot arm kinematics must be able to handle the trocar point limitations without affecting the overall functionality.

3. **Communication channel** Several high bandwidth connections are necessary to handle the data transfer between master and slave. Requirements like guaranteed bandwidth, no (or very low) delays have to be fulfilled, otherwise severe safety problems can occur. The communication subsystem has to be flexible enough allowing the connection of multiple masters to the same slave, or even dynamic on the fly master-slave mapping.

Fulfilling the requirements of each subsystem described above will lead to faster and safer robotic surgery. Faster surgery brings considerable cost reduction on the one hand, and less postoperative complications for the patient on the other hand. In addition there are a few advanced techniques evaluated at research institutes which potentially could enter clinical practice in the near future:

- **Automatic Camera Guidance** Currently available robotic surgery systems leave the camera control to the surgeon. Whenever the camera has to be repositioned the surgeon switches control from the input devices driving the instruments to the camera control mechanism, which is both time consuming and potentially dangerous. Knowing the exact positions of the instruments, consequently also the working area, a robotic system could provide optimal camera positioning to overview that area.
- **Partial Autonomy** Assistance is in traditional surgical procedures a standard practice. Possible (partially) autonomous tasks in a minimally invasive robotic scenario are for example: temporarily holding the needle or the suturing material, grasping of tissue for stretching purposes, automatic suturing and cutting.
- **Organ Motion Compensation** Mainly in the area of thoracoscopic surgery a noticeable amount of motion is due to the patient's heart beat and respiration. The motion of the lung is rather slow (low frequent) and quite easy to track and eventually compensate. Quite to the contrary tracking and compensating heart movements is a challenging task, but it is absolutely necessary for surgery on the beating heart.

The last two items are sophisticated and therefore currently only at research institutes in evaluational use. Several groups at both research institutes and companies are working on minimally invasive robotic surgery systems. The next section gives an overview of such systems, needless to say, this list is far from being complete.

2.1 Experimental Research Setups

Research in this area concentrates mainly to the development of micro-instruments (often equipped with force/torque sensory), robotic arms fulfilling special requirements and force/torque reflective input devices.

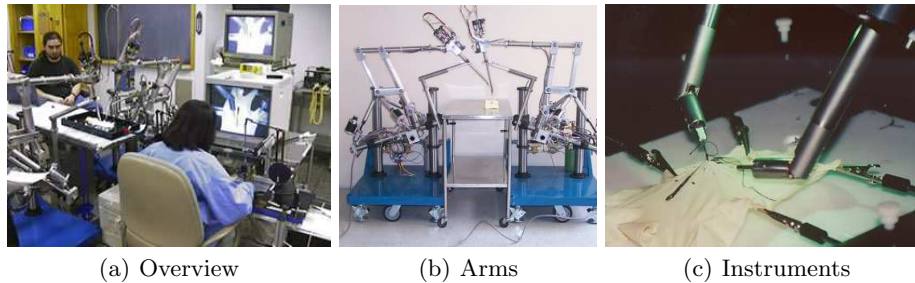

Fig. 7. The "Robotic Telesurgical Workstation for Laparoscopy" at Berkley

The Berkley system In a joint project between the Robotics and Intelligent Machines Laboratory of the University of California, Berkeley (UCB) and the Department of Surgery of the University of California San Francisco (UCSF), a robotic telesurgical workstation (see fig. 7a) for laparoscopy was developed. The current design is a bimanual system with two 6 DOF manipulators instrumented with grippers, controlled by a pair of 6 DOF master manipulators. The slave is based on a modified Millirobot, the masters are the well known PHANToM devices, and as a characteristic the arms are driven by hydraulic actuators. The system provides no force feedback nor stereo vision. The design of the millirobot is dexterous enough to perform suturing and knot-tying tasks. Refer to [9], [10] and [11] for further details.

The KAIST system At the Korea Advanced Institute of Science and Technology (KAIST) a microsurgical telerobot system has been developed. It is composed of a 6 DOF parallel micromanipulator (based on a Stewart platform, see fig. 8c) attached to a macro-motion industrial robot (fig. 8b), and a 6 DOF force/torque-reflective haptic master device (fig. 8a). The master device is using a five-bar parallel mechanism driven by harmonic DC servomotors. According to [12] and [13] this setup doesn't seem to have a (stereo) vision system, but the haptical feedback works quite well. The communication between master and slave is via Ethernet.

The ARTEMIS system Developed at the Forschungszentrum Karlsruhe (FZK) the ARTEMIS system (Advanced Robotic and Telemanipulator System for Minimal Invasive Surgery) was the first German setup for robotic surgery and one of

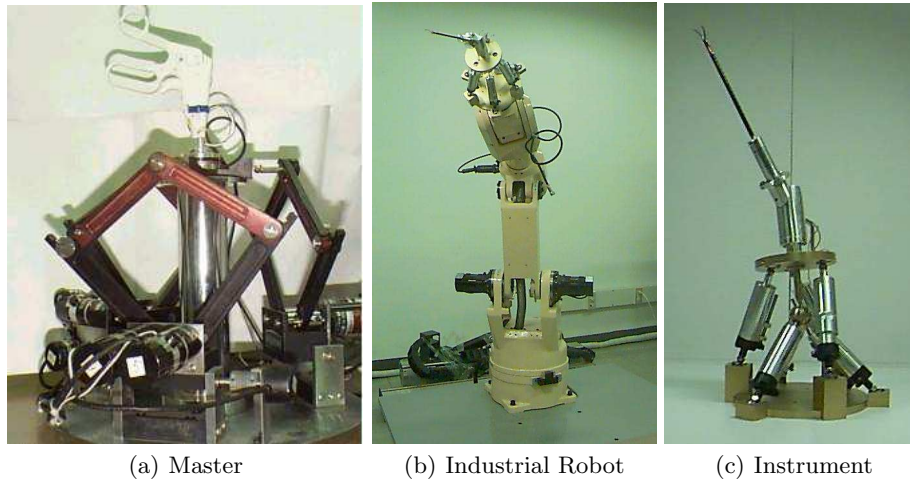

Fig. 8. The "Telerobotic System for Microsurgery" at KAIST

the first worldwide. Even though not further developed it is a technically quite mature system. The ARTEMIS system consists of the following components: Man Machine Interface, Work System and Control System. The Man Machine Interface (fig. 9a) is composed of several devices: two haptic manipulators, graphical user interface, 3D video imaging of the operating environment, speech input (for controlling the laparoscope), foot pedals and a trackball. The Work System (fig. 9b) has two different telemanipulation units: a TISKA based computer controlled carrier system with surgical effectors and a ROBOX computer controlled endoscope guidance system. Knowing the relative position between the TISKA and ROBOX robots allows automatic camera guidance. The Control System provides the cooperation between the other two components of ARTEMIS, the user interface and the work system. Each master on the user interface side can be connected with each slave on the work system side. The kinematics of master and slave do not need to be identical (universal master principal). Different control modes (eg. world coordinates, screen coordinates) as well as different functions (eg. scaling, indexing) can be selected. The communication is via LAN ethernet, and it can even be over larger distances by means of ATM connection. The MONSUN concept is implemented (Manipulator Control System Utilizing Network Technology). Besides the communication, the control system incorporates track control and the safety system. The KISMET 3D-simulation software is also part of the system, the only drawback is the lack of force feedback.

The DLR system At the Deutsches Zentrum für Luft- und Raumfahrt (DLR, Oberpfaffenhofen) a telesurgery scenario has been developed based on modified AESOP 3000 arms (fig. 10a) from Computer Motion, PHANToM input devices from Sensable Technologies and a sensorized scalpell (4 DOF, 3 forces +



Fig. 9. The ARTEMIS system at the FZK

1 torque) developed at the DLR. A prototype of a sensorized 6 DOF forceps is also available, but not yet integrated (fig. 10b). Stereo vision and vision based automatic camera guidance are also available. Cartesian control of the (initially only position controlled) arms allows the validation of more advanced techniques like motion estimation and compensation in beating heart surgery and special control laws (velocity and position/force). The communication between master and slave is CORBA-TCP/IP based.

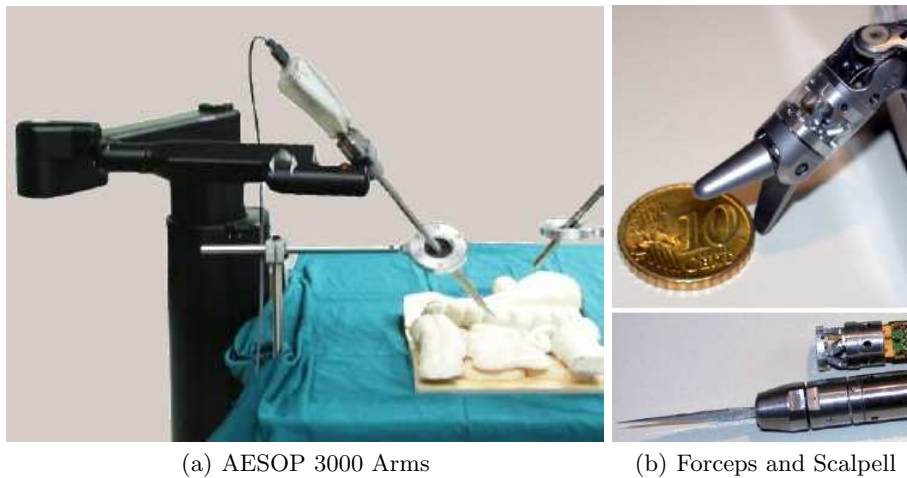

Fig. 10. The system at DLR

The experimental system of the University of Tokio At the University of Tokyo, Department of Engineering Synthesis Faculty of Engineering a tele-endoscopic surgical system with force-feedback capability was developed. According to [19] the system consists of a multi-media cockpit, surgical site and a communication link. The multi-media cockpit (fig. 11a) is equipped with force feedback type master manipulators, visual and auditory information presentation apparatuses and foot switches. A slave manipulator (fig. 11b) with three arms is located at the surgical site. Two arms hold forceps or a radio knife and one arm holds an endoscope. Force sensing capability is equipped on the active forceps to implement force feedback. The (SCARA type) slave manipulator is designed to maintain the insert position at a fixed point for safety. The system was evaluated in an experiment, where the gallbladder of a pig was successfully removed.

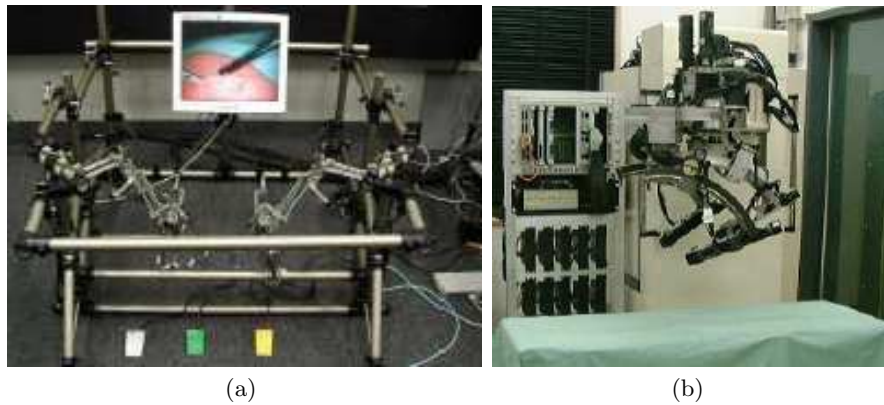

Fig. 11. The experimental system of the University of Tokio

The "Hyper Finger" system A new robotic system named "Hyper Finger" for minimally invasive surgery in deep organs has been developed at the Nagoya University, Department of Micro System Engineering. This is one of the smallest master-slave robots in medicine, each finger has nine degrees of freedom and is driven by wires. A prototypical detachable gripper mechanism was also developed. Note that the master (fig. 12a) is not exoskeletal but hold by the surgeon like a real instrument. This construction doesn't require special robotic arms, the slave can be simply mounted on a camera tripod (fig. 12b). The system provides no force feedback nor stereo vision, but according to [21] the effectiveness of the system was verified by in-vivo experiments. The main field of application seems to be surgical procedures in hardly accessible narrow areas.

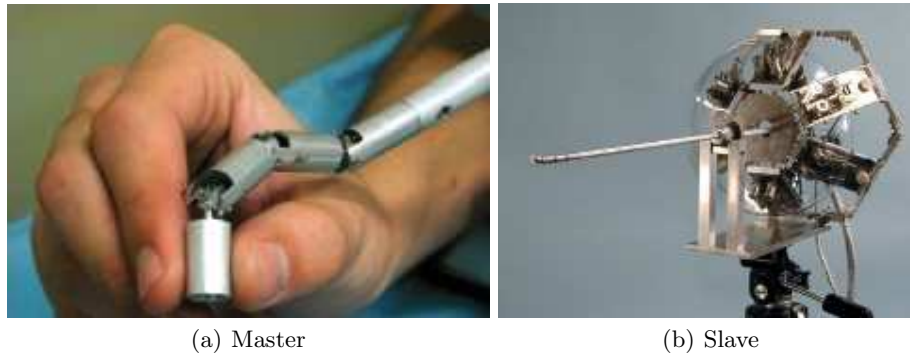

Fig. 12. The "Hyper Finger" system at the Nagoya University

The Remote Microsurgery System A proposal of a new method of microsurgery were made at the Nagoya University, Department of Micro System Engineering. The target of the work is microsurgery in deep, narrow sites of the human body, which are currently the most difficult areas to perform minimally invasive surgery. The proposal contains both a new method of microsurgery and surgical tools. Handling the master (fig. 13a) is similar to a classical endoscopic instrument, the implementation of force feedback could be quite complicated, if intended. The slave (fig. 13b top) doesn't require a robotic arm, it is designed to be mounted on any stable platform in the near of the patient. Then the catheter like guide tube (fig. 13b bottom) can be inserted to the desired operation area. Typical fields of application are neurosurgery, head and neck surgery in otolaryngology and microsurgery on esophageal diseases. According to [20] the system was successfully tested on animals.

2.2 The Experimental Telesurgery System Endo[PA]R

Developed at the Technische Universität München, Chair for Robotics and Embedded Systems [7], the Endo[PA]R (Endoscopic Partially Autonomous Robot) system is an experimental setup which claims applicability in at least animal experiments. A more detailed description is presented in the next sections.

3 Methodology

Similar to other systems, our setup comprises an operator-side master console for in-output and a patient-side robotic manipulator that directly interacts with the operating environment. As shown in Fig. 14, our system has two manipulators, which are controlled by two input devices. Each of the two arms of our surgical robot is composed of the following subsystems. A low-payload robot, which bears a surgical instrument that is deployed with the surgical workstation daVinci

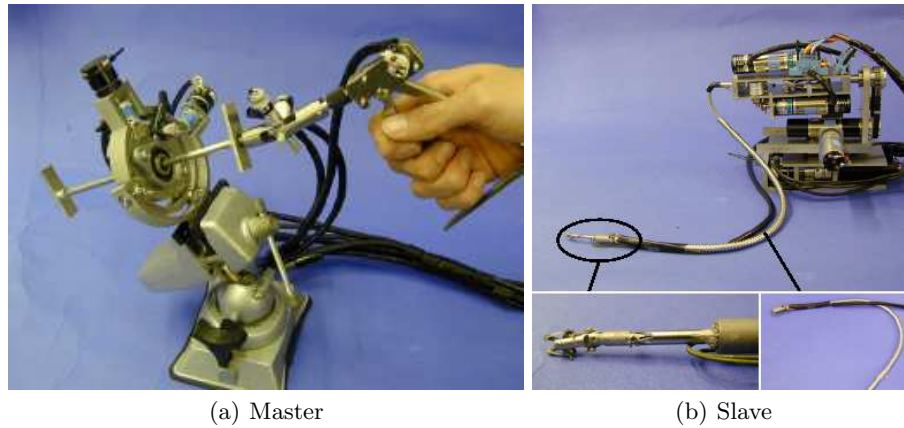

Fig. 13. The Remote Microsurgery System

(TM). We have developed a special adapter that interconnects the robot's flange with the instrument. The surgical instruments have three degrees of freedom. A micro-gripper at the distal end of the shaft can be rotated and adaptation of pitch and yaw angles is possible. Since the yaw angle of each of the two fingers of the gripper can be controlled separately, it is possible to open and close the gripper. All movable parts of the gripper are driven by steel wires. Their motion is controlled by four driving wheels at the proximal end of the instrument, one for each degree of freedom (two for yaw of the fingers). In order to control the instrument, we have flanged servos to each driving wheel by means of an Oldham coupling. This guarantees instrument movement free of jerk. The servo controllers are connected via serial lines to a multi-port interface card. Since the rotation of the robot's flange and the rotation of the instrument share one axis, the combination of robot and instrument results in a manipulator with eight degrees of freedom. That means our system is a redundant manipulator. This can be exploited to evaluate different kinematical behaviors. The most important one is trocar kinematics. This allows 6 dof control of the end effector, while the shaft of the instrument has to be moved about a fixed fulcrum (keyhole surgery). Position and orientation of the manipulators are controlled by two PHANTOM devices (Fig. 14). This device is available in different versions with different capabilities. Our version provides a full 6 dof input, while force feedback is restricted to three translational directions. The user controls a stylus pen that is equipped with a switch that can be used to open and close the micro-grippers. A third robot is carrying an endoscopic stereo camera system. The stereoscopic view is presented via a head mounted display.

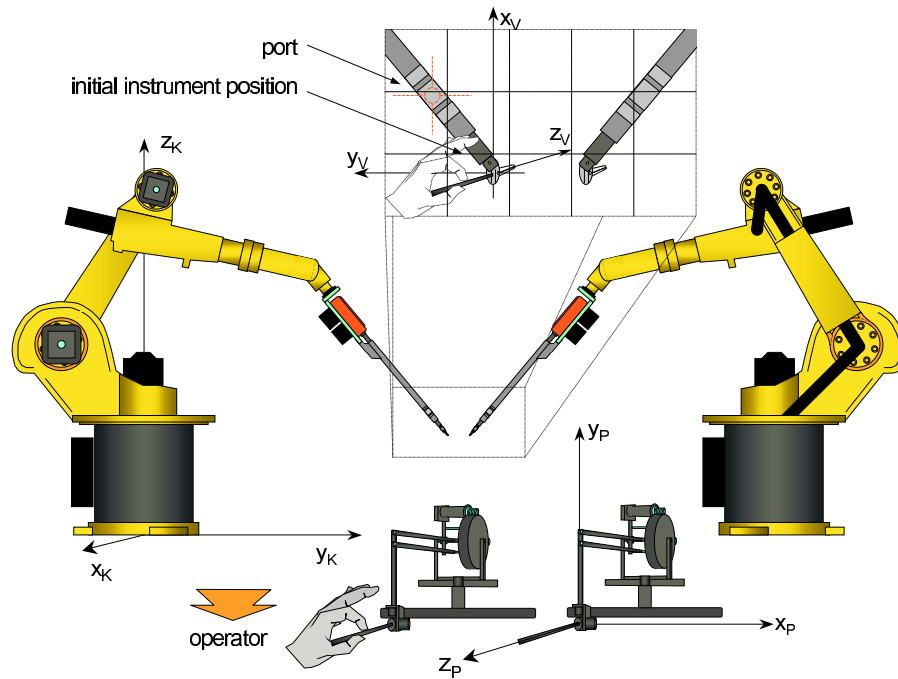

Fig. 14. System Setup

3.1 Force Feedback

The most interesting feature of the PHANToM devices we used, is their capability of providing the user with haptic feedback. Forces are fed back by small servo motors incorporated in the device. They are used to steer the stylus pen in a certain direction. This creates the impression of occurring forces, while the user is holding the pen at a certain posture. The force sensors were applied directly on the shaft of the instrument. Since the shaft of the surgical instrument is made of carbon fibre, force sensors have to be very sensitive and reliable. Therefore we decided to apply strain gauge sensors, which are employed for industrial force registration. As shown in Fig. 15, the sensor gauges are applied at the distal end of the instrument's shaft, i.e. near the gripper. At the top of Fig. 15, one can see the perpendicular arrangement of strain gauges as full bridges. One full bridge of sensors is used for each direction. The signals from the sensors are amplified and transmitted via CAN-bus to a PC system. Sensor readings are blurred with noise, hence we have applied digital filters to stabilize the results. Since we know the position and orientation of the instruments, we can transform occurring forces back to the coordinate system of the PHANToM devices. Therefore the user has the impression of direct haptic immersion.

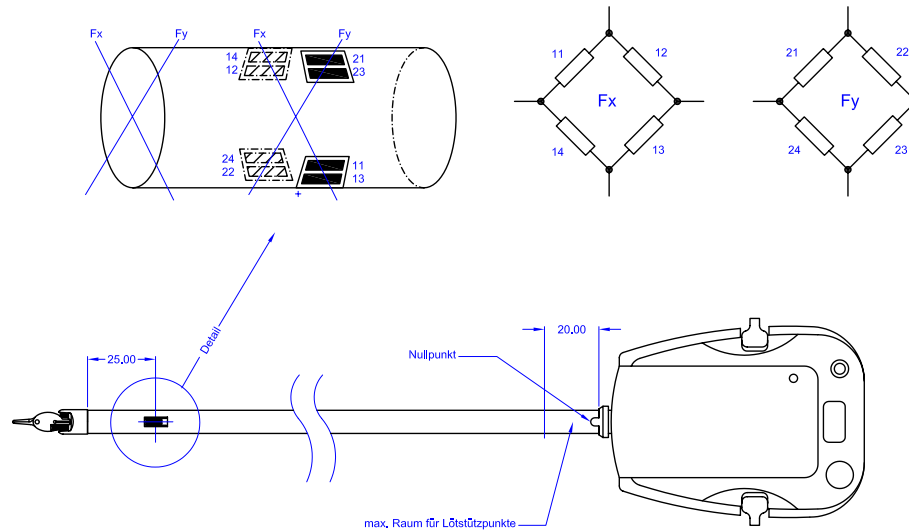

Fig. 15. Application of Strain Gauges to an instrument

3.2 Trocar Kinematics

The basic idea of minimally invasive surgery is, that only small openings have to be made into the surface of the patient's thorax (so-called keyholes, Fig. 16). That means the translational movements of the instruments are essentially restricted by shifts and rotations about these holes. In order to provide the surgeon with a comfortable environment, it is desirable to map the movements of the stylus at the input device directly to instrument motions. Therefore we have to consider the inverse kinematics of our system. That means we have to find a mapping of an arbitrary posture of the instrument's tip to a position of the motors that control the eight degrees of freedom.

The desired position of the instrument is given by the position of the input stylus. It is represented by a homogenous transform matrix. Since the position of the instrument's shaft is restricted by the port (the position of the keyhole), there is only one possibility for aligning the instrument. The angle of the corresponding joints of the instrument can be found by geometric considerations. For result, we get the position of the instrument's shaft. As this axis is identical to the flange axis of the robot, we have got the position of the flange. Given this information, we now can determine the backwards kinematics of the robot. This is a standard procedure, whose detailed calculation will be neglected here. As a final result we can implement a mapping from the position of the input stylus to the position of the instrument. That means the surgeon is provided with a direct remote control of the surgical instruments.

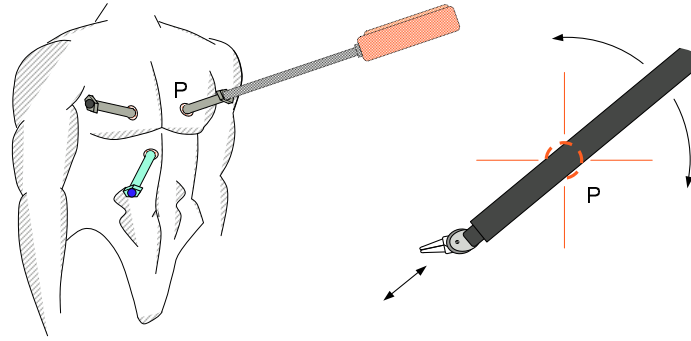

Fig. 16. Trocar Point Kinematics

3.3 System Features

We give only a short list of system features we think to be important. The use of commercially available subsystems (robots, instruments, amplifiers) guarantees reliability and simplifies mass-production at comparable low prices. Particular advantages of this setup with multi-purpose robots are high precision and stiffness, moderate costs and an advanced dynamic behavior. The latter could be exploited to perform advanced tasks in motion compensation (e.g. support for beating heart surgery as it was proposed in [31], or compensation for respiratory motion of the ribs). The modular character of this setup simplifies the adaptation of the system to technical improvements (e.g. new surgical instruments). Another advantage is the fact that our manipulator is a robot under Cartesian control whose position can be controlled precisely. Finally, the most important feature is the possibility for evaluation of force feedback in combination with endoscopic vision in robotic surgery. In order to make navigation easier, we additionally equipped the system with an endoscopic stereo camera system to observe the operation environment.

4 Experimental Results

With the help of this setup we have performed different tasks known from surgical practice and evaluated the impact of force measurement. Our hope is, that haptic feedback contributes to a better performance of systems for robotic surgery by preventing force-induced damages. Examples for such harms are breaking of thread material, ripping tissue and strangulate sutures.

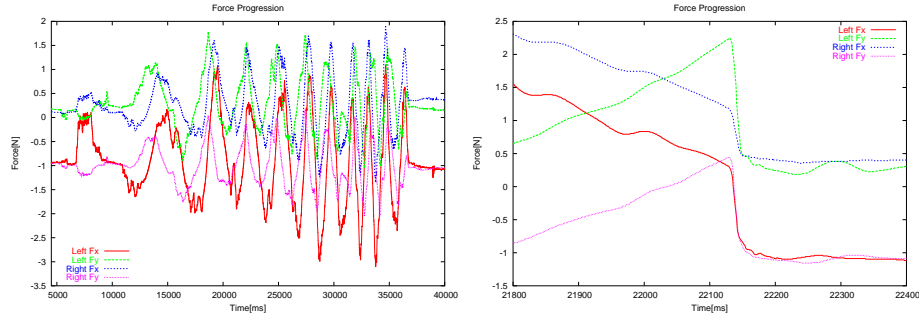

Fig. 17. Winding a thread to make loops

4.1 Winding

The first operation sequence we evaluated was winding thread during knot tying. Forces are acquired only in the XY -Plane perpendicular to the instrument shaft, as our current setup does not yet allow the measurement of forces along the shaft. Winding thread to form loops is a subtask in instrumental knot tying (cf. [32]), and if executed by a surgeon only very low forces arise, since a human operator easily copes with this task using only visual feedback. However in robot assisted surgery scenarios high fidelity force sensory is indispensable, as the visual modality is very difficult to interpret. Accordingly, robotic winding can be accomplished only in a force-controlled manner. On the one hand forces are preferably to be kept constant, on the other hand suture break must be avoided. Fig. 17 (left) shows the force progression during a winding process. The frequency of force peeks in a certain direction grows, as the suture material gets shorter. Nevertheless the forces are quite constant during the whole manipulation. Figure 17 (right) shows a magnified view of an accidental break of the thread during a further winding process. Due to the high time resolution (1 ms) the instant recognition of such suture breaks is possible, preventing the robotic system from unexpected behavior.

4.2 Preventing Suture Material Damage

The tensile strength of absorbable and non-absorbable sutures is critical both during and after surgical procedures. Breaking strength can be measured using either a "straight pull" test or a "knot pull" test. Having the breaking strengths of all used sutures enables us to prevent suture material damage by limiting the applicable forces to adequate maximal values. Fig. 18 (left) shows the progression of forces while trying to break original surgical suture material, in this case Ethicon PROLENE (7/0, Polypropylen, not absorbable). Fig. 18 (right) shows breaking the thread (PROLENE 7/0) while tying a knot. As expected, the thread was broken at the knot position by significantly less force impact.

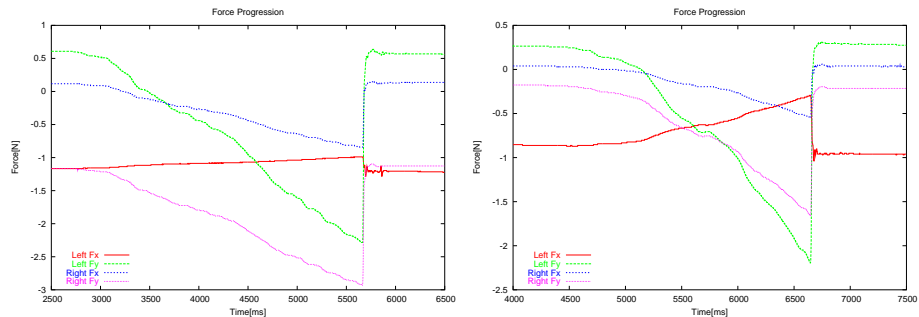

Fig. 18. Breaking Ethicon 7/0 by normal pulling (left) and knot tying (right)

4.3 Collision Detection

Avoiding the collision of the instruments in robot assisted minimally invasive surgery is not an easy task. Therefore a symbolic representation of the whole robotic system, including both the instruments and the arms, were necessary. Furthermore exact position control and a collision detection software subsystem are indispensable. Most setups however do not provide the above mentioned infrastructure. A human operator will easily avoid instrument collisions, but in an autonomous mode other solutions are necessary. A force controlled setup will not prevent collisions, but an early detection can avoid from damaging the instruments. Figure 19 shows the forces recorded while an instrument collision, the instrument velocities were within ranges typical to this scenario. We observe, that the highest peak (Y -force component of the left instrument) arises in approximately $35ms$. With a robot arm interpolation of $12ms$ there are nearly 3 interpolation periods to react when such a situation appears, providing a satisfactory collision interception.

5 Simulation

In order to check certain operation sequences (e.g. the complicated procedure of knot-tying) before applying them to the real world, we have developed a realistic simulation of our system. Since the model has the same geometry as the real system, all joint angles obtained from the inverse kinematics can be directly applied to it. The model is displayed in an *Open Inventor*-GUI. Input data can be recorded to a data base for subsequent use with the simulation or the real system. This simulation was especially useful to detect some unusual motion sequences that could lead to failures of the real system. For example, the robot tends to move too fast if the instrument tips approach come too close to the port. The simulation can also be used in parallel with real manipulations. This can be very helpful if the remote user has no full sight of the operation environment (e.g. if instruments are occluded by other objects).

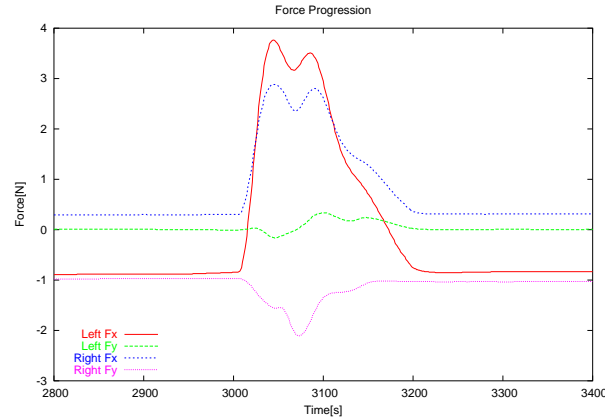

Fig. 19. Colliding instruments

Fig. 20 shows the simulation environment including a CT-scan of the thorax and heart phantom. A detailed closeup view of the operation situs is depicted in the lower right corner of the simulation window. The exact model allows for an appropriate instantiation of previously acquired tasks, since transformation parameters (translation, rotation, scaling) can be extracted from simulation. A possible scenario is automatically completing a knot: as an occurrence of an already recorded manipulation sequence is recognized, a context-sensitive instance of that sequence is replayed. Before the task is actually completed by the robotic system, a virtual execution is displayed to the surgeon, who can choose between either discarding or performing the task.

6 Partial Autonomy

We have performed several knot-tying tasks with our system and recorded both, force progression and the corresponding trajectories (described by position and orientation of the instruments). Due to inevitable physiological tremor of the human operator, the acquired trajectories exhibit some noise. Therefore two-stage preprocessing was applied to the raw data. The first stage comprises sliding window averaging, the second stage approximates the smoothed data with natural cubic splines.

Our first experiment was replay of an original sample with no smoothing and approximation applied. Since our system features a high repeat accuracy, this procedure was performed very reliable. The only prerequisite is positioning the needle at a known place. Since we leave the needle placement to the surgeon and we know the geometry of our system, we can always exactly locate the corresponding position. Due to exact kinematics, execution of up to double speed has raised no difficulties. As our objective is not restricted to acceleration, we also want to generate optimized trajectories with respect to smoothness and path

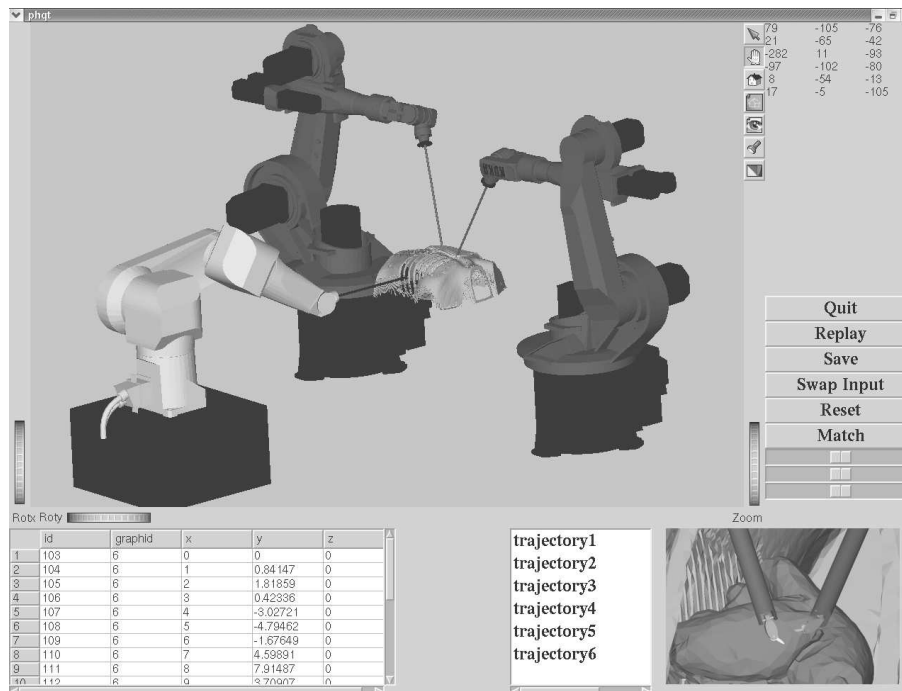

Fig. 20. Screenshot of the Simulation Environment

planning. Therefore we have applied spline approximation to the raw data (see fig. 21 right) . This results in a symbolic representation of the trajectory in the form of a parametric space-curve. Before applying the generated curve to the real system, collision avoidance has to be guaranteed, since overmodified paths can contingently result in instrument collision.

7 Conclusions and Outlook

We have presented a novel approach of a robotic system for minimally invasive surgery. It is mainly composed of commercially available subsystems. This has several advantages like precision, reliability and a good dynamic behavior. The main purposes of the system are evaluation of force feedback and machine learning. We found out that performance of certain surgical tasks like knot tying will profit from this feature. Experiments have shown that haptic feedback can be employed to prevent the surgeon from potentially harmful mistakes. Tension of thread material and tissue parts can be measured and displayed in order to restrict force application to a tolerable amplitude. Collision of instruments can be detected and intercepted by real-time force evaluation. Forces are measured at the surgical instruments and fed back into the surgeon's hands using multi-dimensional haptic styluses. For future evaluation we are planning long-term

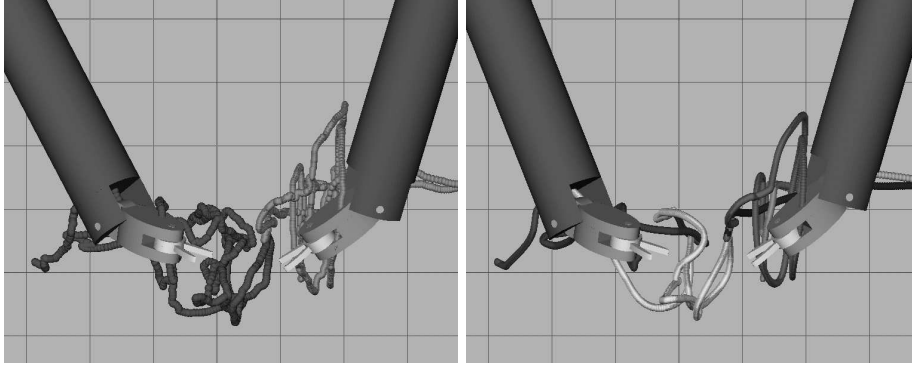

Fig. 21. Raw and Spline-Approximated Trajectory (Knot-Tying)

tests to find out if force feedback can prevent surgeon's fatigue. The current arrangement of input devices, however, is not very comfortable. Therefore we are planning to test different rearrangements of this setup and to develop own input instruments to replace the stylus pens. Additionally we are planning to include measurement of torques and their incorporation in the control loop of the system. Currently we are also working on a simulation environment that can be used to model haptic interaction with a tissue model. This can be applied for off-line evaluation of critical tasks.

Integration of force feedback with stereo vision, as offered by the system, can improve accuracy, drastically reduce the time needed for operations and tissue trauma, along with a reduction of stress on the surgeon. This could lead to a wider acceptance of robotic surgery by both, patients and surgeons. The system's software interface and mechanical set-up descriptions are freely available to enable other research groups to participate in the development.

References

1. <http://www.kuka.de>
2. <http://www.intuitivesurgical.com>
3. <http://www.computermotion.com>
4. <http://www.robodoc.com>
5. <http://www.urs-ortho.de>
6. <http://www.armstrong-healthcare.com>
7. <http://www6.in.tum.de>
8. <http://www.hbm.de>
9. Murat Cenk Cavusoglu, Frank Tendick, Michael Cohn and S. Shankar Sastry: *A Laparoscopic Telesurgical Workstation*. IEEE TRA, Vol. 15, No. 4, August 1999.
10. M. Cenk Cavusoglu, Winthrop Williams, Frank Tendick, S. Shankar Sastry: *Robotics for Telesurgery: Second Generation Berkley/UCSF Laparoscopic Telesurgical Workstation and Looking towards the Future Applications*. Industrial Robot, Special Issue on Medical Robotics, Vol. 30, No. 1, January 2003.

11. Murat Cenk Cavusoglu: *Telesurgery and Surgical Simulation: Design, Modeling, and Evaluation of Haptic Interfaces to Real and Virtual Surgical Environments*. PhD Thesis, UC Berkeley, August 2000.
12. Dong-Soo Kwon, Ki Young Woo, Se Kyong Song, Wan Soo Kim, Hyung Suck Cho: *Microsurgical Telerobot System*. IEEE/RSJ International Conference on Intelligent Robots and Systems, pp. 945-950, 1998.
13. Dong-Soo Kwon, Ki Young Woo, Hyung Suck Cho: *Haptic Control of the Master Hand Controller for a Microsurgical Telerobot System*. IEEE ICRA, Detroit, Michigan, May 1999.
14. U. Voges, E. Holler, B. Neisius, M. Schurr, T. Vollmer: *Evaluation of ARTEMIS, the Advanced Robotics and Telemanipulator System for Minimally Invasive Surgery*. Proceedings IARP 2nd Workshop on Medical Robotics, Forschungszentrum Karlsruhe, 1997, pp. 137-148.
15. Fuji Lai and Robert D. Howe: *Evaluating Control Modes for Constrained Robotic Surgery*. IEEE ICRA, San Francisco, CA, April 2000.
16. V. F. Muñoz, C. Vara-Thorbeck, J. G. DeGabriel, J. F. Lozano, E. Sanchez-Badajoz, A. García-Cerezo, R. Toscano and A. Jimenez-Garrido: *A Medical Robotic Assistant for Minimally Invasive Surgery*. IEEE ICRA, San Francisco, CA, April 2000.
17. Gary S. Guthart, J. Kenneth Salisbury: *The IntuitiveTM Telesurgery System: Overview and Application*. IEEE ICRA, San Francisco, CA, April 2000.
18. Mamoru Mitsuishi, Shin Tomisaki, Takumi Yoshidome, Hiroyuki Hashizume and Kazuo Fujiwara: *Tele-micro-surgery system with intelligent user interface*. IEEE ICRA, San Francisco, CA, April 2000.
19. Mamoru Mitsuishi, Jumpei Arata, Katsuya Tanaka, Manabu Miyamoto, Takumi Yoshidome, Satoru Iwata, Shin'ichi Warisawa and Makoto Hashizume: *Development of a Remote Minimally-Invasive Surgical System with Operational Environment Transmission Capability*. IEEE ICRA, Taipei, Taiwan, September 2003.
20. Koji Ikuta, Keiichi Yamamoto and Keiji Sasaki: *Development of Remote Microsurgery Robot and New Surgical Procedure for Deep and Narrow Space*. IEEE ICRA, Taipei, Taiwan, September 2003.
21. Koji Ikuta, Takahiko Hasegawa and Shinichi Daifu: *Hyper Redundant Miniature Manipulator "Hyper Finger" for Remote Minimally Invasive Surgery in Deep Area*. IEEE ICRA, Taipei, Taiwan, September 2003.
22. P. Berkelman, E. Boidard, P. Cinquin, J. Troccaz: *LER: The Light Endoscope Robot*. IEEE/RSJ, Las Vegas, Nevada, October 2003.
23. M. Tavakoli, R.V. Patel and M. Moallem: *A Force Reflective Master-Slave System for Minimally Invasive Surgery*. IEEE/RSJ, Las Vegas, Nevada, October 2003.
24. P. Knappe, I. Gross, S. Pieck, J. Wahrburg, S. Kuenzler, F. Kerschbaumer: *Position control of a surgical robot by a navigation system*. IEEE/RSJ, Las Vegas, Nevada, October 2003.
25. M.D. O'Lary, C. Simone, T. Washio, K. Yoshinaka and A.M. Okamura: *Robotic Needle Insertion: Effects of Friction and Needle Geometry*. IEEE ICRA, Taipei, Taiwan, September 2003.
26. A.M. Okamura, R.J. Webster III, J.T. Nolin, K.W. Johnson and H. Jafry: *The Haptic Scissors: Cutting in Virtual Environments*. IEEE ICRA, Taipei, Taiwan, September 2003.
27. Wei Tech Ang, Pradeep K. Khosla and Cameron N. Riviere: *Design of All-Accelerometer Inertial Measurement Unit for Tremor Sensing in Hand-held Microsurgical Instrument*. IEEE ICRA, Taipei, Taiwan, September 2003.

28. Mark Minor, Ranjan Mukherjee: *A Dexterous Manipulator for Minimally Invasive Surgery*. IEEE ICRA, Detroit, Michigan, May 1999.
29. Roger Baumann and Reymond Clavel: *Haptic Interface for Virtual Reality Based Minimally Invasive Surgery Simulation*. IEEE ICRA, Leuven, Belgium, May 1998.
30. Mamoru Mitsuishi, Yasuhiro Iizuka, Hiroyoshi Watanabe, Hiroyuki Hashizume and Kazuo Fujiwara: *Remote operation of a micro-surgical system*. IEEE ICRA, Leuven, Belgium, May 1998.
31. T. Ortmaier, M.Groeger and G. Hirzinger: *Robust Motion Estimation in Robotic Surgery on the Beating Heart*. Computer Assisted Radiology and Surgery (CARS), 2002.
32. C. Cao, C. MacKenzie and S. Payandeh: Task and motion analyses in endoscopic surgery, Proceedings ASME Dynamic Systems and Control Division, pp. 583-590, Atlanta, USA, 1996